

Operator's Manual

ASCO® 7000 Series ACTB Automatic Closed-Transition Transfer & Bypass-Isolation Switches 150, 260, and 400 amp. sizes

TABLE OF CONTENTS

	section-page
INSTALLATION	1-1
Mounting	1-1
Power Connections	1-1
Engine Starting & Auxiliary Circuits	1-1
Functional Test	1-2, 1-3
TESTING & SERVICE	2-1
Transfer Test	2-1
Preventive Maintenance	2-1
Disconnecting the Controller	2-1
Manual Load Transfer	2-2
Trouble-Shooting	2-2
BYPASSING & ISOLATING	3-1
Bypassing the ATS	3-1
Isolating the ATS	3-2
Return to Service	3-3
INDEX	back cover

Note: Refer to the outline and wiring drawings provided with your 7000 Series ACTB for all installation and connection details and accessories.

Note: Refer to *Group 5 Controller User's Guide* 381333-126 for ATS status display messages, time delays, pickup & dropout settings, and adjustments.

Rating Label

Each 7000 Series ACTB contains a rating label to define the loads and fault circuit withstand/closing ratings. Refer to the label on the Transfer Switch for specific values.

WARNING

Do not exceed the values on the rating label. Exceeding the rating can cause personal injury or serious equipment damage.

Nameplate

The Transfer Switch nameplate includes data for each specific 7000 Series 7ACTB. Use the switch only within the limits shown on this nameplate. A typical Catalog Number is shown below with its elements explained:

An experienced licensed electrician must install the ACTB.

Catalog Number Identification

Typical 7000 Series ACTB catalog no. for overlapping neutral, 3 pole, 400 amp., 480 V, in Type 1 enclosure:

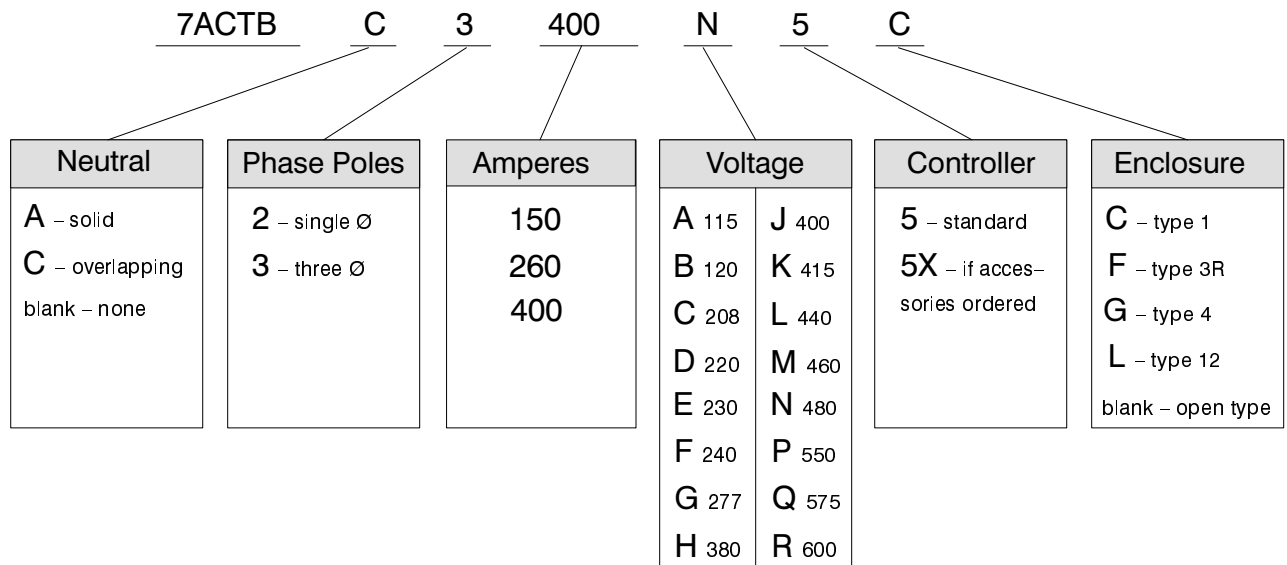

SECTION 1 INSTALLATION

The ASCO 7000 Series Automatic Closed–Transition Transfer & Bypass–Isolation Switch (ACTB) consists of an upper bypass–isolation switch, a lower transfer switch, a monitoring and transfer controller, and door–mounted controls. The ACTB is factory wired & tested.

CAUTION

Protect the switch from construction grit and metal chips to prevent malfunction or shortened life for the ACTB switch.

CAUTION

To prevent damage to open–type switches, use care when lifting them. Fasten lifting chains or hooks to the main structural parts of the switch, such as the main panel or mounting rails. Do not damage moving linkages, shafts, contacts, wires, and control contacts.

Mounting

Refer to the enclosure outline drawing furnished with this switch and mount the 7000 Series ACTB according to the details and instructions shown on the drawing.

It is not necessary to remove the barriers from the bypass switch and transfer switch. If you do remove them, however, reinstall them carefully.

Enclosed switches have the controller mounted on the upper door. For open–type switches, mount the controller in the door with appropriate size cutout and mounting studs (as shown on the drawings). Do not exceed the length of the harness; provide stress relief.

Harnesses

All internal connections are made at the factory. The bypass switch, transfer switch, and controller are joined together by an interconnecting wire harness. The disconnect plugs are already engaged on enclosed switches. For open–type switches, the plugs must be engaged after installation is completed. Align harness plugs with sockets in the controller and push them together until they are secure.

Power Connections

A *Wiring Diagram* is furnished with the ACTB. All wiring must be made in accordance with the the National Electrical Code and local codes.

Do not run cables behind the switch. Cables can be bundled on the right side of the switch. Maintain proper electrical clearance between the live metal parts and grounded metal: ½ inch minimum. Remove the cover shields from the bypass switch to connect power cables to

Emergency lugs and overlapping neutral lugs (if neutral code C is provided). Reinstall the cover shields carefully.

DANGER

De–energize the conductors before making any line or auxiliary circuitry connections. Be sure that Normal and Emergency line connections are in proper phase rotation. Place engine generator starting control in the OFF position. Make sure engine generator is not in operation.

DANGER

Reinstall the cover shields over the Emergency lugs and overlapping neutral lugs (if provided). If this shield is not in place when the switch is energized, the lugs are exposed. Touching these energized lugs will cause shock, burns, or death!

Connect the power cables to the appropriate terminal lugs on the Bypass Switch as shown on the wiring diagram provided with this ACTB. Make sure that the lugs provided are suitable for use with the cables being installed. Standard terminal lugs are solderless screw type and will accept the wire sizes listed on the drawings provided with the ACTB. Be careful when stripping insulation from conductors; avoid nicking or ringing the conductor. Remove surface oxides from conductors by cleaning with a wire brush. Follow conductor manufacturer’s instructions when aluminum conductor is used. Apply joint compound to conductor, then carefully wipe away excess compound. Tighten the cable lugs to the torque specified on the rating label.

CAUTION

Be sure that the Normal and Emergency power connections are in proper phase rotation.

Controller Ground

A grounding wire must be connected to the controller’s lower left mounting stud. Because the controller is mounted on the enclosure door, a conductive strap must be used between the enclosure and the door. This connection provides proper grounding which does not rely upon the door hinges.

Engine Starting Contacts and Auxiliary Circuits

The engine control contact signal connections and auxiliary circuits are located on a terminal block as shown on the *Wiring Diagram* provided with the ACTB. Connect the signal wires to the appropriate terminals.

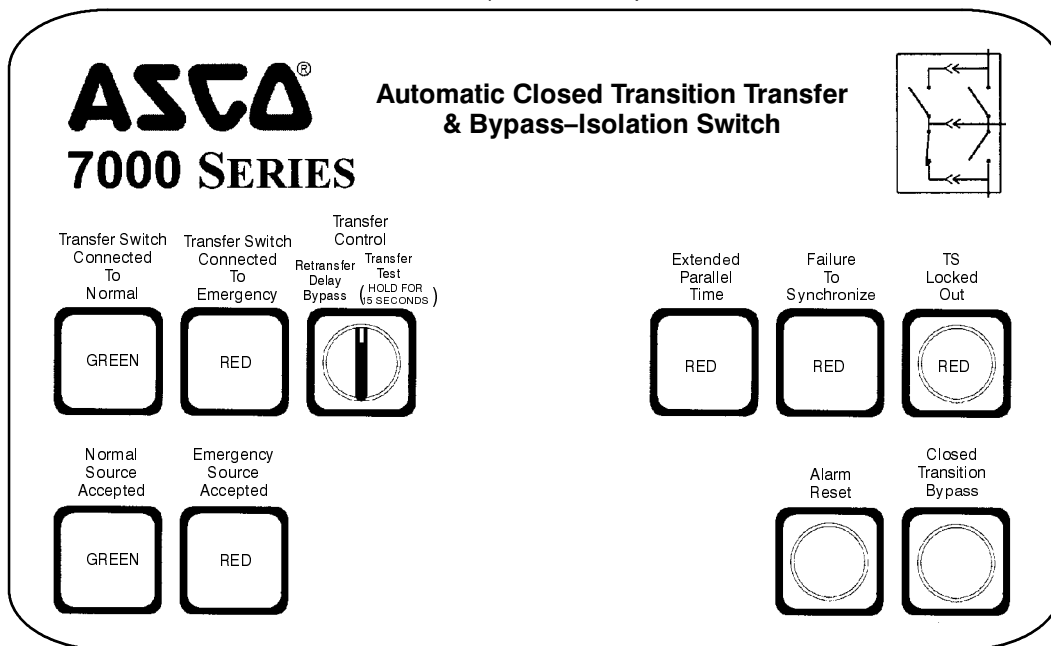

Figure 1-1. Standard controls and indicators.

Functional Test

Read all instructions on the *Wiring Diagrams* and labels affixed to the ACTB. Note the control features that are provided and review their operation before proceeding.

After installing the ACTB check the following:

- Bypass Handle should be in the *NORMAL* position.
- Isolation Handle should be in the *TEST* position.
- CN transfer switch should be in the *C* (closed) position.
- CE transfer switch should be in the *O* (open) position.

If handles are not in correct positions, follow instructions for Bypassing and Isolating the automatic transfer switch in **Section 3**. **Do not force the handles**. Electrical interlocks prevent a wrong sequence of operation.

1 - Voltage Checks

First check nameplate on transfer switch; rated voltage must be the same as normal and emergency line voltages.

⚠ **DANGER**

Use extreme caution when using a meter to measure voltages. Do not touch power terminals; shock, burns, or death could result !

Perform steps 1 through 6 at the right. Observe the status lights. See Figure 1-1.

- Black square means light is on.
- White square means light is off.

* If necessary, adjust voltage regulator on generator per the manufacturer's recommendations. The ACTB will respond only to rated voltage specified on the nameplate.

Now continue to **2 - Electrical Operation** on next page.

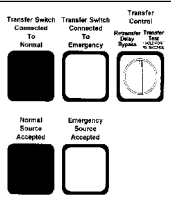
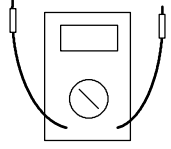
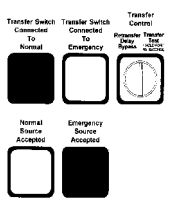
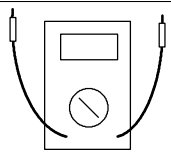
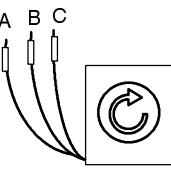
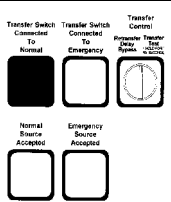
1	<p>Close the normal source circuit breaker. The <i>Transfer Switch Connected To Normal</i> and the <i>Normal Source Accepted</i> lights should come on.</p>	
2	<p>Use an accurate voltmeter to check phase to phase and phase to neutral voltages present at the transfer switch normal source terminals.</p>	
3	<p>Close the emergency source circuit breaker. Turn the Engine Control switch to <i>Run</i> to start the generator. The <i>Transfer Switch Connected To Normal & Emergency Source Accepted</i> lights should come on.</p>	
4	<p>Use an accurate voltmeter to check phase to phase and phase to neutral voltages present at the transfer switch emergency source terminals.*</p>	
5	<p>Use a phase rotation meter to check phase rotation of emergency source; it must be the <u>same</u> as the normal source.</p>	
6	<p>Turn Engine Control switch to <i>Auto</i> to stop the generator. The <i>Emergency Source Accepted</i> light should go off. Then put the starting control selector switch (on generator set) in <i>automatic</i> position. Close enclosure door.</p>	

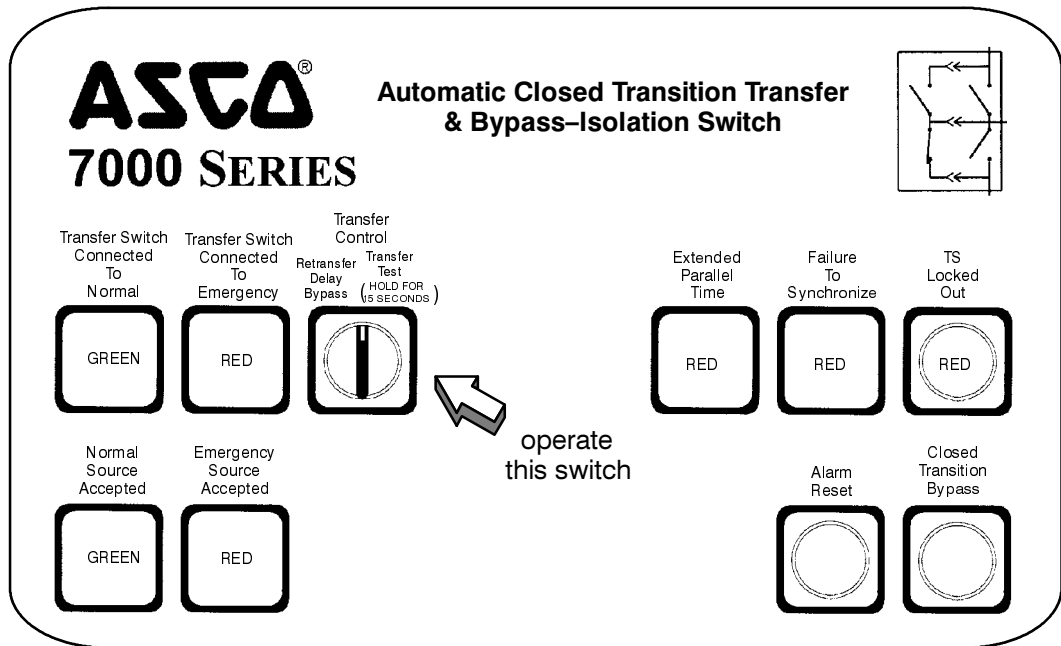

Figure 1-2. Standard controls and indicators.

2 – Electrical Operation

This procedure checks electrical operation of the ATS.

⚠ WARNING

Be sure to close the enclosure door before proceeding to prevent personal injury in case of electrical system fault.

Transfer Test

The ATS should still be bypassed and isolated. Both normal and emergency sources must be available and the emergency source generator (if used) must be capable of being started; put engine starting control in *automatic* position. The *Transfer Switch Connected to Normal* light and the *Normal Source Accepted* light should be on.

1. Turn the **Isolation Handle** to the *TEST* position.
NOTE: The engine generator may be signalled to start while turning the Isolation Handle. If emergency source is available, the ATS may operate to the emergency position. If it does, operate **Retransfer Delay Bypass** switch.
2. Perform steps 1 – 4 at right. Observe the status lights.
 - Black square means light is on.
 - White square means light is off.
3. Push in and turn the **Isolation Handle** clockwise to the *CLOSE* position.
4. Turn the **Bypass Handle** to the *AUTO* position.

This completes the Functional Test of the ACTB.

1	Turn and <u>hold</u> Transfer Control switch clockwise to <i>Transfer Test</i> until the engine starts and runs (within 15 sec.). The <i>Emergency Source Accepted</i> light should come on.	
2	Transfer switch CE closes and then Transfer Switch CN opens (closed-transition overlap). The <i>Transfer Switch Connected to Emergency</i> light should come on and the <i>Transfer Switch Connected to Normal</i> light should come on (you might see and hear the brief overlap transfer).	
3	Transfer switch will operate back to Normal position after Feature 3A time delay. For immediate retransfer turn Transfer Control counterclockwise to <i>Retransfer Delay Bypass</i> . The <i>Transfer Switch Connected to Normal</i> light should come on; <i>Transfer Switch Connected to Emergency</i> light should go off.	
4	The engine-generator will stop after the Feature 2E time delay (unloaded running engine cool-down). The <i>Emergency Source Accepted</i> light should go off.	

SECTION 2 TESTING & SERVICE

TRANSFER TEST

Test the Automatic Closed–Transition Transfer Switch portion of the 7000 Series ACTB at least once a month. This procedure checks the electrical operation of the Transfer Switch and Controller. Put the engine–generator starting control (at the engine–generator set) in automatic mode.

In the following test the generator will start, the load will be transferred to the Emergency source, then back to the Normal source. An interruption to the load will occur, unless the the Transfer Switch contacts are bypassed before the test. See pages 3–1 and 3–2 for bypassing & isolating instructions if no interruption of load is required.

WARNING

Be sure to close the enclosure door before proceeding to prevent personal injury in case of electrical system fault.

Perform the four–step **Electrical Operation – Transfer Test** procedure on page 1–4.

PREVENTIVE MAINTENANCE

Reasonable care in preventive maintenance will insure high reliability and long life for the 7000 Series ACTB. An annual preventive maintenance program is recommended.

ASCO Services, Inc. (ASI) is ASCO Power Technologies' national service organization. ASI can be contacted at 1–800–800–2726 for information on preventive maintenance agreements.

Checklist for Yearly Inspection

DANGER

Hazardous voltage capable of causing shock, burns, or death is used in this switch. Deenergize both Normal – Emergency power sources before performing inspections!

- Clean the ATS enclosure.** Brush and vacuum away any excessive dust accumulation. Remove any moisture with a clean cloth.
- Check the transfer switch contacts.** Remove transfer switch barriers and check the condition of the contacts. Replace contacts when pitted or worn excessively. Reinstall the barriers carefully.
- Maintain transfer switch lubrication.** If switch is subjected to severe dust or abnormal operating conditions, renew factory lubrication on all movements and linkages. Relubricate solenoid operator if TS coil is replaced. Don't use oil; order *lubrication kit 75–100*.
- Check all cable connections & retighten them.**

REPLACEMENT PARTS

Replacement parts are available in kit form. When ordering parts provide the Serial No., Bill of Material No. (BOM), and Catalog No. from the transfer switch nameplate. Contact your local ASCO Power Technologies–Sales Office or ASI:

call 1 – 800 – 800 – ASCO (2726)

DISCONNECTING THE CONTROLLER

The harness disconnect plugs are furnished for repair purposes only and should not have to be unplugged. If the control panel must be isolated, follow these steps:

DANGER

Bypass–Isolation Switch is energized! Do not touch isolation contact fingers; shock, burns, or death could result!

Disconnecting the Plugs

1. Bypass and Isolate the Automatic Transfer Switch.
2. Open the upper enclosure door.
3. Separate the two quick disconnect plugs by squeezing the latches. Do not pull on the harness wires.

Reconnecting the Plugs

1. The ATS should be still bypassed and isolated.
2. The two harness plugs and sockets are keyed. Carefully align the plugs with the sockets and press straight in until the latches click.
3. Close the enclosure doors.
4. Follow *Return to Service* instructions on page 3–3.

TESTING & SERVICE *(continued)*

TROUBLE-SHOOTING

Note any optional accessories that may be furnished on the ACTB and review their operation. Refer to any separate drawings and/or instructions that may be packed with the ACTB.

Table 2-1. Trouble-Shooting Checks.

PROBLEM	CHECK IN NUMERICAL SEQUENCE		
	1 OPERATION	2 GEN-SET	3 VOLTAGE
Engine-generator set does not start when the Transfer Control switch is turned and held in <i>Transfer Test</i> position or when normal source fails.	Hold <i>Transfer Test</i> switch 15 seconds or the outage must be long enough to allow for Feature 1C time delay plus engine cranking and starting.	Starting control must be in the automatic position. Batteries must be charged and connected. Check wiring to engine starting contacts.	-
Transfer switch does not transfer the load to the emergency source after the engine-generator set starts.	Wait for Feature 2B time delay to time out.	Generator output circuit breaker must be closed. Generator frequency must be at least 95% of nominal (57 Hz for a 60 Hz system.) *	Voltmeter should read at least 90% of nominal phase to phase voltage between terminals EA and EC (or EL1 and EL2 for 2 pole switches)*
Transfer switch does not transfer the load to normal source when normal returns or when the Transfer Control switch is released.	Wait for Feature 3A time delay to time out.	-	Voltmeter should read at least 90% of nominal phase to phase voltage between terminals NB and NC, NC and NA, and NA and NB (or NL1 and NL2 for 2 pole switches).
Gen. does not stop after load retransfer to normal source.	Wait for Feature 2E time delay to time out.	Starting control must be in the automatic position.	-
<i>Failure to Synchronize</i> light comes on.	Conditions of Normal or Emergency Sources not suitable for closed transition transfer. Recheck voltage and frequency of both sources. Press Alarm Reset pushbutton.		
<i>Extended Parallel Time</i> light comes on.	CN and CE contacts are closed longer than setting in the Controller. Open the disconnected source circuit breaker, then call your nearest ASCO Services for assistance.		
<i>TS Locked Out</i> light comes on.	Transfer lockout operation has occurred; transfer switch is disabled from automatic operation. Open the disconnected source circuit breaker, then call your nearest ASI for assistance.		

* These are factory settings.

Refer to **Controller User's Guide**.

If the problem is isolated to circuits on the controller or the transfer switch, call your local ASCO Power Technologies sales office or ASI at 1-800-800-2726. Furnish the Serial No. and Catalog No. from the transfer switch nameplate.

MANUAL LOAD TRANSFER

This procedure manually transfers load to other source if the transfer switch or controller are out of service.

⚠ **WARNING**

Close enclosure doors to prevent personal injury in case of electrical system fault.

1. Be sure that the Bypass Handle is in either the *EMERGENCY* or *NORMAL* position (see page 3-1).
2. Be sure that the Isolation Handle is in the *TEST* or *OPEN* position (see page 3-2).
3. Turn the Bypass Handle to the *AUTO* position, then continue turning the Bypass Handle to the other source (see page 3-1).

⚠ DANGER

Hazardous voltage capable of causing shock, burns, or death is used in this switch. Do not touch the power or load terminals of the switch!

MAINTENANCE HANDLE

⚠ DANGER

Bypass and isolate Transfer Switch before using the maintenance handle! See page 3-1.

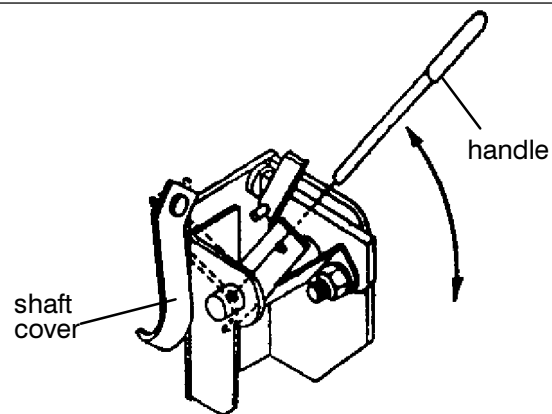

Swing the shaft cover to the left out of the way. Install the maintenance handle into the hole in the shaft, left side. Move the maintenance handle up or down to transfer to the opposite position. Then remove the maintenance handle and swing shaft cover back over end of the shaft.

SECTION 3 BYPASSING & ISOLATING

BYPASSING

This procedure explains how to Bypass the closed automatic transfer switch contacts. Bypassing is required before the ATS can be tested or isolated. The Bypass Switch must be in the *AUTO* position & the Isolation Switch contacts must be closed.

1. Observe which *LOAD CONNECTED TO* light is on (*NORMAL* or *EMERGENCY* on the door. It is the position of the automatic transfer switch.
2. Bypass to the same source connected to the load as follows (select direction). Refer to Figure 3-1, Figure 3-2, and Figure 3-3.

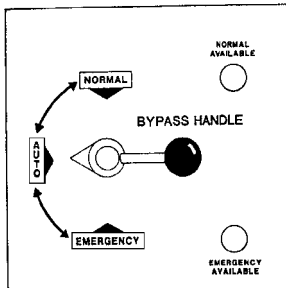

Figure 3-1. Bypass Handle.

To Bypass Normal Source

Turn the **Bypass Handle** clockwise to *NORMAL*.

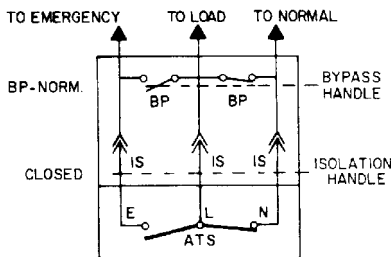

Figure 3-2. Bypass to Normal.

To Bypass Emergency Source

Turn the **Bypass Handle** counterclockwise to *EMERGENCY*.

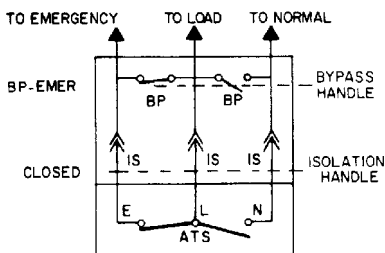

Figure 3-3. Bypass to Emergency.

The automatic transfer switch can now be put in the *TEST* or *OPEN* position. See **ISOLATING**.

ISOLATING

This procedure explains how to isolate the automatic transfer switch. Isolating is required before any service work can be performed on the ATS. Observe the *LOAD CONNECTED TO* lights on the door.

1. Bypass the closed automatic transfer switch contacts. See **BYPASSING**.
2. Isolate the automatic transfer switch as follows. Refer to Figures 3-4, 3-5, and 3-6.

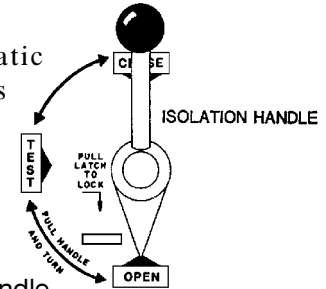

Figure 3-4. Isolation Handle.

⚠ CAUTION

Align handle indicator. Do not leave the handle in an intermediate position.

To Isolate the Automatic Transfer Switch

NOTE: The engine generator may be signaled to start while turning the Isolation Handle to or from the *TEST* position.

Turn the **Isolation Handle** counterclockwise to the *TEST* position. Then **pull out** the Isolation Handle and continue turning it to the *OPEN* position. To lock the handle, pull out the locking lever in the faceplate and insert a padlock through the hole in the locking lever.

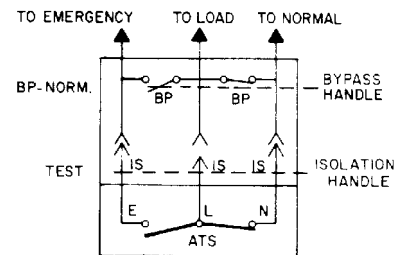

Figure 3-5. Isolate to Test.

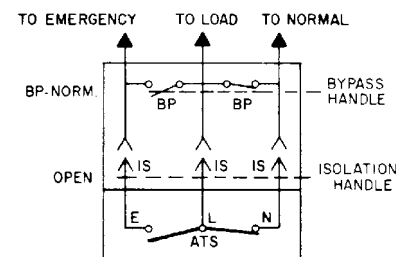

Figure 3-6. Isolate to Open.

The lower transfer switch can now be removed for inspection and maintenance. See page 3-2.

BYPASSING & ISOLATING (continued)

TRANSFER SWITCH REMOVAL

This procedure explains how to remove the transfer switch for inspection and maintenance.

1. Bypass and Isolate the automatic transfer switch by carefully following directions on page 3-1. Padlock the Isolation Handle in the *OPEN* position

⚠ DANGER

Hazardous voltage capable of causing electrical shock, burns, or death is used in this ACTB. Do not touch any control circuit terminals.

2. Open the enclosure door (loosen the screws).
3. Separate the in-line disconnect plugs by squeezing the plugs. Do not pull on the harness wires. Label, tape, and disconnect wires to auxiliary contacts.
4. Release the transfer switch as follows:

⚠ WARNING

Hold 75 lb Transfer Switch firmly when lifting the panel latch to prevent it from falling outward. Failure to do so could cause personal injury or damage to the switch.

Hold the transfer switch with your left hand while lifting the panel latch with your right hand. The transfer switch will tilt outward on the floor rails. It weighs about 75 pounds. See Figure 3-7.

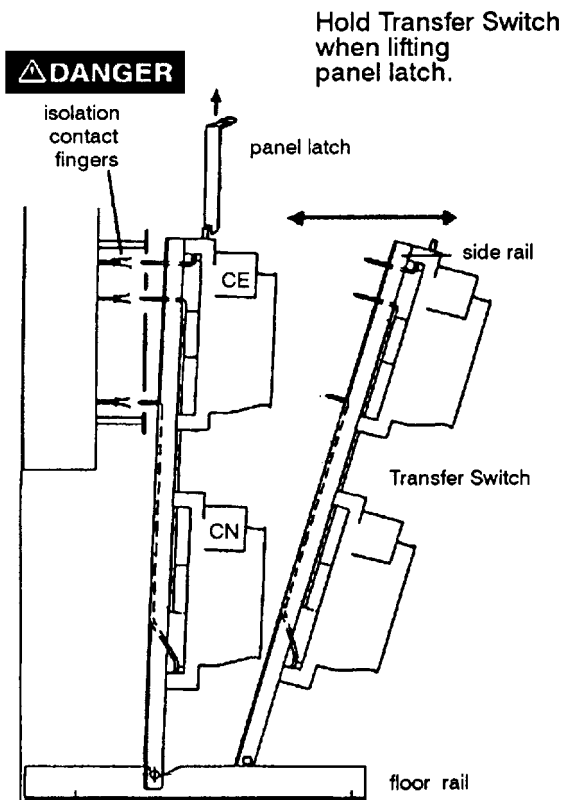

Figure 3-7. Transfer switch removal.

5. Remove the transfer switch by sliding it toward you on the floor rails.

⚠ WARNING

Transfer switch weighs about 75 pounds. Be careful when lifting it to avoid personal injury.

Grasp the side rails of the transfer switch; do not lift at any other points (protect barriers). Then lift the transfer switch out of the cabinet. The transfer switch weighs about 75 pounds. See Figure 3-7.

6. Close the enclosure door and tighten the screws.

TRANSFER SWITCH REINSTALLATION

This procedure explains how to install the transfer switch after inspection and maintenance.

⚠ DANGER

Hazardous voltage capable of causing electrical shock, burns, or death is used in this ACTB. Do not touch any control circuit terminals.

1. Open the enclosure door (loosen the screws).

⚠ CAUTION

All arc chutes and pole covers must be in place on the Transfer Switch.

⚠ CAUTION

The Transfer Switch contacts must be closed on the same source that is feeding the load (use the maintenance handle – see page 2-2).

2. Install the transfer switch as follows:

Grasp side rails of Transfer Switch; do not lift at any other points (protect barriers). Lift the Transfer Switch onto the floor rails and slide it inward until it drops into notches in the floor rails. See Figure 3-7.

3. Secure the transfer switch as follows:

Push in the transfer switch until the panel latch catches the top of the transfer switch panel. Check that the latch is all the way down. See Figure 3-7.

4. Reconnect in-line disconnect plugs by grasping & pressing them together. Be sure to connect the correct plugs.
5. Close the enclosure door and tighten the screws.
6. Unlock the Isolation Handle. Carefully follow directions on page 3-3 to return the switch to service.

BYPASSING & ISOLATING (continued)

RETURN TO SERVICE

This procedure explains how to return the automatic transfer switch to service after inspection and maintenance. Observe the *Transfer Switch Connected To* lights on the door.

1. Install the transfer switch into enclosure by carefully following directions on page 3-2.

⚠ WARNING

Close enclosure door to prevent personal injury in case of electrical system fault.

2. Turn **Isolation Handle** clockwise to the *TEST* position (see Figure 3-8):

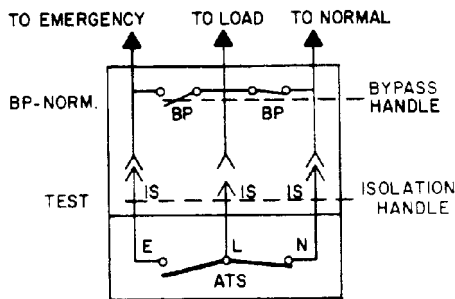

Figure 3-8. Test position.

Electrical Operation Test: This procedure will check the electrical operation of the automatic transfer switch without interrupting the load. It still should be Bypassed.

Transfer Test

Perform the 5-step *Transfer Test* procedure on page 1-3.

3. Observe the position of the Bypass Handle's pointer. This position indicates the source that is bypassed.
4. Observe which *Transfer Switch Connected To* light is on (*Normal* or *Emergency*). This light indicates the position of the transfer switch. If it is not in the same position as the Bypass Switch, change the transfer switch position as follows:

To change the position of transfer switch

Operate to NORMAL	Operate to EMERGENCY
Turn Transfer Control switch counterclockwise to <i>Retransfer Delay Bypass</i> .	Turn Transfer Control switch clockwise to <i>Transfer Test</i> and hold.*
<i>Transfer Switch Connected to Normal</i> light should come on.	<i>Transfer Switch Connected to Emergency</i> light should come on.

* If Feature 2B time delay is used, there will be a delay before transfer to Emergency.

NOTE: With Normal available, the automatic transferswitch will not stay in the emergency position unless Feature 3A time delay is used (at least 30 seconds).

⚠ WARNING

Do not close the isolating contacts unless the transfer switch and bypass switch are in the same position.

5. Turn the **Isolation Handle** clockwise to the *CLOSE* position (Figure 3-9).

⚠ CAUTION

Align handle indicator. Do not leave the handle in an intermediate position.

NOTE: The engine generator may be signaled to start while turning the Isolation Handle to or from the *TEST* position.

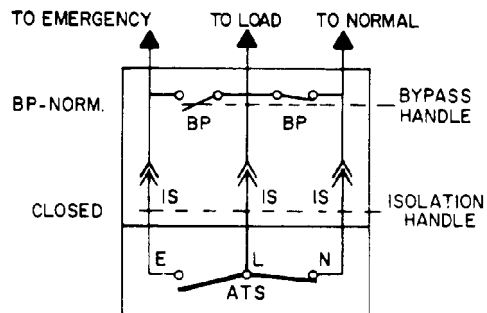

Figure 3-9. Closed position (Isolation contacts are fully engaged.)

6. Turn **Bypass Handle** to *AUTO* position (Figure 3-10).

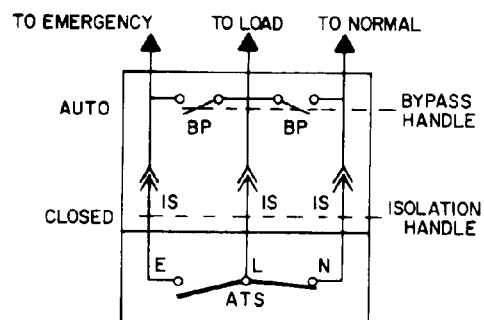

Figure 3-10. Auto position.

INDEX

A

auxiliary circuits, 1–2

B

bypassing the ATS, 3–1

C

catalog number, cover

cleaning, 2–1

closed–transiton transfer, 1–3

connections

power, 1–1

controller

disconnecting, 2–1

see *Controller User's Guide*

E

electrical operation, 1–4

Emergency Source Accepted light,
1–3

engine starting contacts, 1–2

Extended Parallel Time light, 2–2

F

Failure to Synchronize light, 2–2

frequency, generator, 2–2

functional test, 1–2, 1–3

H

harness, 1–2

disconnect plugs, 2–1

I

inspection, 3–1

installation, 1–1

isolating the ATS, 3–1

L

lights, 1–2, 1–3

load connected to emergency, 1–3

load connected to normal, 1–3

lubrication, 2–1

M

maintenance, preventive, 2–1

maintenance handle, 2–2

warning, 2–2

manual load transfer, 2–2

warning, 2–2

N

nameplate, cover

Normal Source Accepted light, 1–3

O

operation

electrical, 1–3

manual, 2–2

warning, 2–2

P

parts, 2–1

phase rotation check, 1–3

preventive maintenance, 2–1

problem, 2–2

R

rating label, cover

replacement parts, 2–1

return to service, 3–3

S

service

ASCO Services, Inc. (ASI), 2–1

settings

see *Controller User's Guide*

T

test, functional, 1–2, 1–3

testing power cables, 1–2

time delays, 2–1

see *Controller User's Guide*

TS Locked Out light, 2–2

Transfer Control selector switch

Retransfer Delay Bypass, 1–3

Transfer Test, 1–3

Transfer Switch Connected To
Emergency light, 1–3

Transfer Switch Connected To
Normal light, 1–3

transfer test, 1–3, 2–1

transfer to emergency, 1–4, 2–1

transfer to normal, 1–4, 2–1

troubleshooting, 2–2

V

voltage checks, 1–3

voltage, pickup and dropout settings

see *Controller User's Guide*