

INSTALLATION AND OPERATING INSTRUCTIONS



Q-Series

PROTRAN[®]

MANUAL TRANSFER SWITCHES

FROM

RELIANCE
CONTROLS

Residential Wattage Requirements

Appliance	Running Watts	Add watts for starting
Furnace blower, gas or fuel		
1/8 hp	300	500
1/8 hp	500	750
1/6 hp	500	750
1/4 hp	600	1000
1/3 hp	700	1400
1/2 hp	875	2100
Shallow well pump		
1/3 hp	750	1400
1/2 hp	1000	2350
Sump pump		
1/3 hp	800	1300
1/2 hp	1050	2150
Refrigerator or freezer	800	2300
Garage door opener		
1/4 hp	550	1100
1/3 hp	750	1400
Lights	on bulb	0
Radio	50-200	0
Television	100-300	0
Microwave oven	600-1500	0
Coffee maker, typical	1750	0
Toaster/toaster oven	1050-1850	0
Portable heater	1100-1500	0
Dehumidifier	650-800	0
Electric blanket	400	0
Clothes washer	1150	2300
Clothes dryer, gas	700	1800
Dishwasher		
cool dry	700	1400
hot dry	1450	1400
Vacuum cleaner	800-1100	0
Hair dryer	300-1500	0
Iron	1200	0

Warnings • Cautions



Warning: Improper installation of this transfer switch could cause damage or personal injury by electrocution or fire. Installation must be performed by a qualified electrician in compliance with all applicable electrical codes



Caution: Reliance transfer switches covered in this manual should not be used for appliances or systems that may exceed the capacity of the product.



Caution: When the transfer switch is connected to branch circuits with AFCI or GFCI breakers, the AFCI or GFCI protection will be lost when, and only when, the toggle switch in the transfer switch is in the GEN position. To get AFCI or GFCI protection when running on generator power, it must be provided at the outlet(s).

Reliance Controls Corporation is not responsible for damage or injury caused by incorrect installation of this transfer switch.



Member, National Electrical Manufacturers Association



GeneratorJoe

4016 Quartz Drive
Santa Rosa, CA 95405
Phone: 707 539-9003
Fax: 707 539-5212
Email: sales@generatorjoe.NET
Web www.generatorjoe.NET

Reliance Installation and Operating Instructions

Key Components of the Reliance Transfer Switch

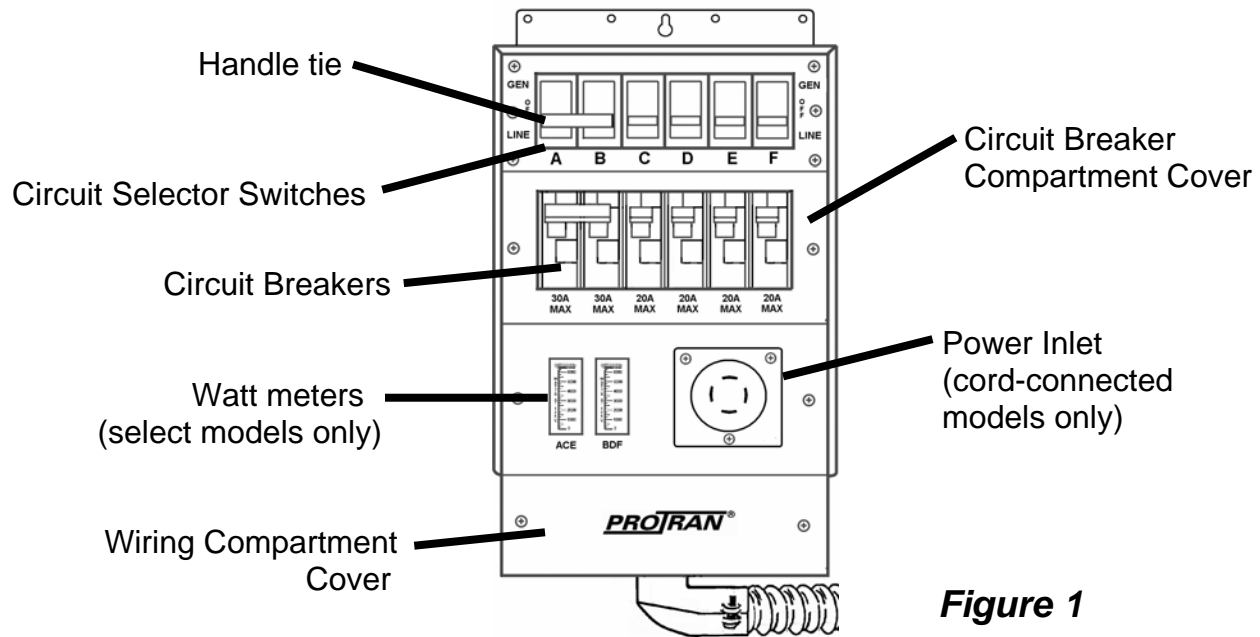

Figure 1

Circuit breakers. Each transfer switch circuit has a 1-in interchangeable circuit breaker that protects the branch circuit when the circuit selector switch is in the GEN position. In the LINE position, each branch circuit is protected by the breaker in the load center.

Circuit selector switches. These switches allow you to select either GEN (generator) or LINE (utility) as the power source for the branch circuits that have been wired through the transfer switch. The OFF position is generally not used, as a switch in the OFF position removes that branch circuit from both utility and generator power.

Handle ties. Handle ties are used for 240-volt circuits or multi-wire branch circuits. They may be removed for 120-volt circuits. See page 6 for instructions on removing and adding handle ties.

Power inlet (selected models only). The power cord from the generator is plugged into this inlet. Not needed for hard-wire installation with remote power inlet box.

Power inlet filler plate. Models without the power inlet installed have a filler plate covering the hole in the wiring compartment cover. This can be replaced with a power inlet. Models with a power inlet installed have a filler plate included in the unit carton. This can replace the power inlet for hard-wire installation.

Wiring Compartment Cover. All models include a wiring compartment that can be used to hard-wire the unit to a remote power inlet box.

Analog wattmeters (suffix -A and -C models). These meters indicate the total load, in watts, on each side of the generator when the generator is supplying power as follows:

The left meter measures the load on	
A, C, and E	6-circuit
A, C, E, G and I	10-circuit

The right meter measures the load on	
B, D and F	6-circuit
B, D, F, H and J	10-circuit

Note: The watt meters will register only if power is being used from the generator.

Electronic wattmeter (suffix -AE and -CE models). Two sets of LED readouts (a long and a short) appear on the face of the meter. The left set applies to the circuits shown in the left box above, with the longer scale indicating the total wattage supplied from the generator to those circuits, and the shorter scale indicating the relative generator output voltage on those circuits. In a similar manner, the right set applies to those circuits shown in the right box above. A green readout indicates that voltage and amperage are within an acceptable range. In addition, a “mains on” indicator appears in the upper left corner, and will be lit when utility power is available and the main circuit breaker in the load center is in the “on” position. The generator must also be connected and running for the “mains on” indicator to operate properly.

Installation Instructions

Preparing for Installation

You will need the following items:

- Electric drill
- Screwdriver
- Wire cutters/stripper
- Hammer
- Four anchors and screws
- 6 or 10 yellow wire connectors (depending on the model)
- 4 red wire connectors for the 20A and 30A hard-wire models

The following five steps generally apply to all transfer switch installations. The transfer switch may be installed on either side of the load center.

1. Turn off the main circuit breaker in the load center to ensure your safety.



Danger: All current-carrying parts on the LINE side of the main are still live

2. Remove the cover of the load center.
3. Locate and remove a knockout (ko) in the bottom of the load center (*Figure 2*). Use a 3/4" ko for 6-circuit models, and a 1" ko for 10-circuit models.
4. Insert the wires extending from the end of the flexible conduit through the ko. Attach the conduit connector securely with the locknut provided.
5. Anchor the transfer switch to the wall using the top bracket and bottom mounting holes located in the cabinet behind the wiring compartment cover. Do not attempt

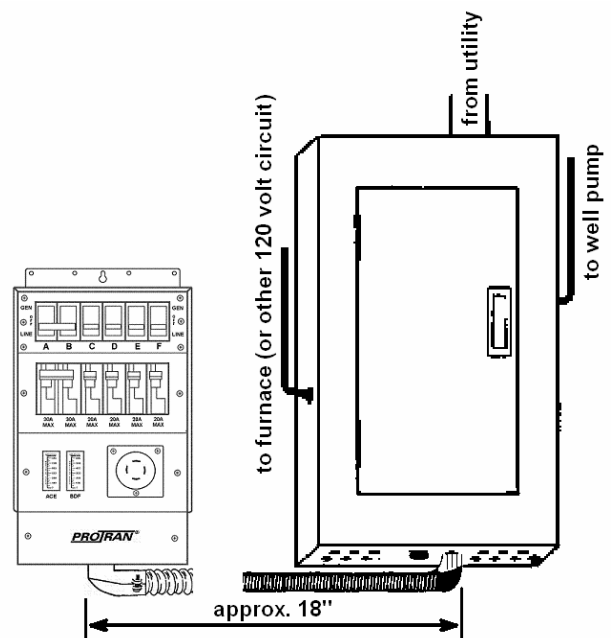

Figure 2

to bend the flexible conduit beyond its structural capabilities.

Wiring the Reliance Transfer Switch to the Load Center

Determine which circuits will be used during an emergency. The residential wattage requirement chart on the inside front cover of this manual may be used as a guide, but actual appliance wattages may vary. If a selected circuit is part of a multi-wire branch circuit, ensure the other branch circuit that shares the neutral is also connected to the transfer switch. The two circuits must be connected to opposing legs (phases) of the generator power and a handle tie must be installed on the switch handles so that both legs are transferred at the same time.



Warning: Failure to properly install a multi-wire branch circuit could result in overloading the neutral wire.

The maximum number of circuits available and those that can be used for multi-wire branch circuits depends on the model of the transfer switch as follows:

Model	Max	Available for multi-wire branch circuits
Q206, Q306, Q506	6	Any two adjacent circuits.
Q310, Q510	10	Any two adjacent circuits.

Balancing the Load

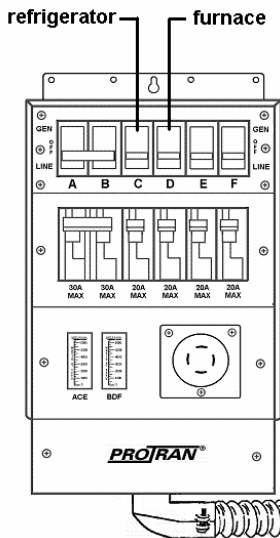

To maximize the efficiency of your generator, divide appliance circuits and others requiring higher wattage between adjacent circuit selector switches of the transfer switch so that a usage balance is achieved between the opposing legs of the generator power.

For example, on a 6-circuit transfer switch, consider wiring the refrigerator to Switch A and the furnace to Switch D (*Figure 3*).

Figure 3

Changing Circuit Breakers

This product is supplied with a combination of 15- and 20-amp circuit breakers. In some cases, a 30 amp double-pole breaker may be supplied in the A and B positions. All circuit breaker positions will accommodate 15- and 20-amp circuit breakers, and may be easily changed in the field. To remove a circuit breaker, remove the circuit

breaker compartment cover, unscrew the terminal screw in the breaker to be removed, removed the wire, tilt the top of the circuit breaker towards you and lift up and out. Reverse the procedure to install another breaker. In addition, positions A and B (but only these positions) will accommodate 30-amp circuit breakers.

This product is UL approved for use with the following field-installed breakers:

Siemens	Type QP
Square D	Type HOM
Eaton Cutler-Hammer	Type BR
Murray	Type MP

30 amps maximum in positions A and B, 20 amps maximum in all other positions.

Rating of a transfer switch circuit breaker should not exceed the rating of the corresponding branch circuit breaker in the load center.

Do not install any breaker larger than 20 amps., except in positions A and B which may be 30 amps.

Installing 120-volt Circuits



Warning: Transfer switch circuits with 20 amp breakers must be installed on only those branch circuits with 20 amp branch circuit breakers. Transfer switch circuits with 15 amp breakers can be installed on 15 or 20 amp branch circuits. **Do not install any transfer switch circuit on branch circuits greater than 20 amps, except in position A and B which maybe 30 amps.**

Wire the most critical circuits first, starting with any circuit position on the transfer switch. Let's assume that Switch C will be designated to supply power to the refrigerator.

1. Turn off the refrigerator circuit breaker. Loosen the screw that secures the wire to the circuit breaker. Disconnect the wire from the circuit breaker.
2. On the transfer switch, find the black and red wires marked C.
3. Feed the **red wire** to the selected **breaker**, in this case the refrigerator breaker.
4. Cut the red wire C to a convenient length. Strip approximately 5/8" from the end of the wire. Connect the **red wire** to the refrigerator circuit **breaker** and retighten the screw.
5. Cut the black wire C to a convenient length for aligning with the wire removed from the refrigerator circuit breaker in step 1. Strip approximately 5/8" from the end of the wire.
6. Insert both wires (the wire removed from the circuit breaker in step 1 and the black wire) into a yellow wire connector. Twist the connector tightly and push the wires back into the wiring compartment of the load center.

This completes the installation of the transfer switch for your refrigerator.

Repeat steps 1-6 for each of the remaining considering the following:

- See the following section for 240-volt circuits and the removal of handle ties if 240-volt circuits are not required.
- Remember to "balance the load"—dividing the appliances requiring higher wattage between the left and right sides of the transfer switch.

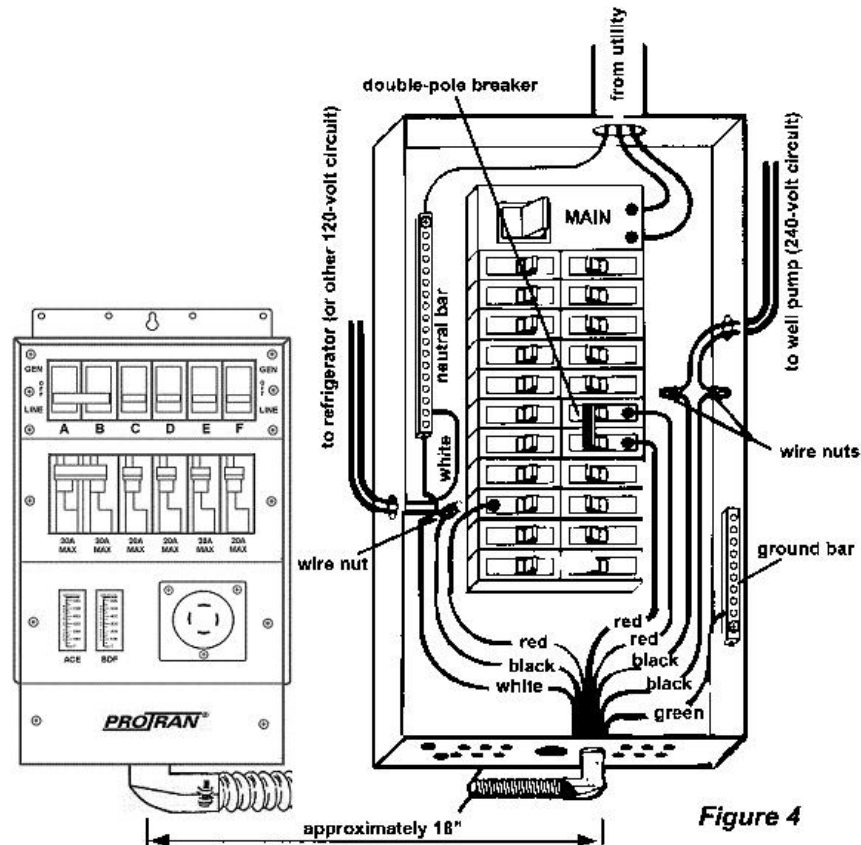

Figure 4

Installing 240-volt Circuits

Any two adjacent circuit selector switches may be used for a double-pole 240-volt circuit. Use a handle tie to connect the two circuit selector switches.

*Note: Circuits used for multi-wire branch circuits are not available for 240-volt circuits

Removing handle ties. If there are no 240-volt or multi-wire circuits in the transfer switch installation, handle-ties on the switches are not needed. To remove a handle tie, place the handle-tied switch in the GEN position. Loosen the two screws and remove the handle tie.

Adding handle ties. If additional ties are needed to accommodate additional 240-volt or multi-wire circuits, they can be added to adjacent pairs of switches.



Warning: Transfer switch circuits with 20 amp breakers must be installed on only those branch circuits with 20 amp branch circuit breakers. Transfer switch circuits with 15 amp breakers can be installed on 15 or 20 amp branch circuits. **Do not install any transfer switch circuit on branch circuits greater than 20 amps, except in position A and B which maybe 30 amps.**

Installing 240-volt circuit(s)

1. Locate the two red and two black wires from any adjacent circuit positions.
2. Turn off the double-pole breaker in the load center.

3. Loosen the screws that secure each wire to each circuit breaker. Disconnect the wires from the circuit breakers.
4. Feed the two red wires in Step 1 to the double-pole circuit breaker.
5. Cut the red wires to a convenient length. Strip 5/8" from the end of each wire. Connect the two **red wires** to the double-pole circuit **breaker**.
6. Cut the black wires to a length convenient for aligning with wires removed from the circuit breaker. Strip 5/8" from the end of each wire.
7. Insert one wire removed from the circuit breaker and one black wire into a yellow wire connector. Twist to tighten and push the wires back into the wiring compartment of the load center. Do the same for the other wire removed from the circuit breaker and the other black wire from the transfer switch.
8. Be sure that a handle tie is connected between the two circuit selector switches.

Repeat steps 1-8 for the other double-pole circuits.

30-Ampere Circuits. Only circuits A and B may be used for 30-amp. circuits. Follow the above wiring instructions for installing 240-volt circuits. If 30-amp. single-pole circuits are being used, refer to the previous section regarding installation of 120-volt circuits.

For models with -C or -D suffix, or to hard wire any cord-connected model, continue to the next section entitled "Hard-wire Installation" to complete the installation.

For all other models, skip to "Completing the installation" on page 8.

Hard-wire Installation

"Hard-wire" installation to a power inlet box located remotely from the transfer switch (*Figure 6*) requires additional steps to complete the installation. The wire connections to the wires from power inlet box are made in the wiring compartment of the transfer switch. Access the wiring compartment by removing the two screws located on the sides of the lower wiring compartment cover. Replace when installation is complete. For models with wattmeters, see wattmeter sections below before making the following connections.

For models having a terminal block in the wiring compartment, connect to the remote power inlet box as follows:

From the transfer switch, connect:

- the black terminal to the power inlet X or Y terminal
- the white terminal to the power inlet neutral W terminal
- the red terminal to the power inlet X or Y terminal
- the green terminal to the power inlet ground G terminal.

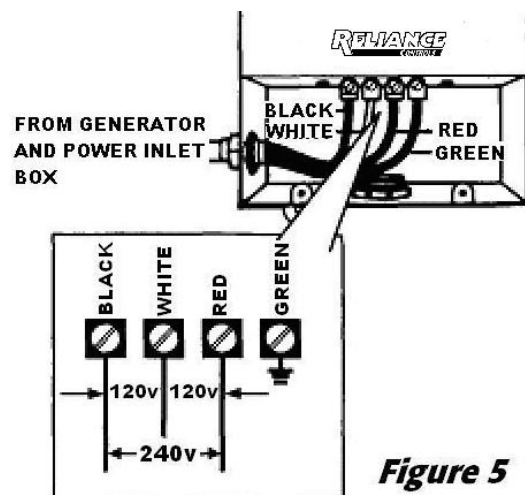
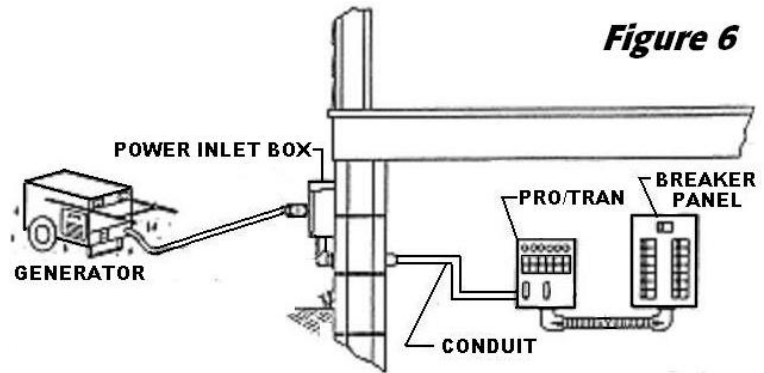

Figure 5

Certain models have color-coded wire leads instead of a terminal block. Connect the wire leads to the remote power inlet box using the same color key as used for wiring the terminal block above (see Figure 5).

Models with suffix -A, -AE, and -B can be hard-wired by removing the power inlet and connecting the wire leads as described in the preceding paragraph. Install the plastic cover included with the unit over the inlet opening after the inlet is removed.

Models with Analog Wattmeters (suffix -A and -C). Most of these models are factory pre-wired. When connecting an analog watt meter equipped transfer switch to either a power inlet or power inlet box, run the black wire lead going to the inlet through the hole in the current transformer (the small black doughnut-shaped device) attached to the left hand meter. Run the red wire lead through the hole in the current transformer attached to the right hand meter. No direct connection to the meter is necessary for the meters to function as described on the bottom of page 2.



Models with Electronic Meter (suffix -AE and -CE). These models are factory prewired at the terminal block located on the bottom wiring compartment cover.

Completing the Installation

When you have wired all the load circuits in the transfer switch, only the white neutral wire and the green ground wire remain.

1. Insert the white neutral wire into an unused opening in the neutral bar in the load center and tighten the screw (*Figure 4*).
2. Insert the green ground wire into an unused opening in the ground bar, if existing, and tighten the screw. If no ground bar exists, insert the green wire into an unused hole in the neutral bar and tighten the screw.
3. Replace the cover to the load center.
4. Fill in the chart on the transfer switch to identify your emergency circuits and corresponding circuit numbers in the load center.
5. Return all load center branch circuit and main breakers to the "ON" position.
6. Move all circuit selector switches on the transfer switch to the "LINE" position.

Installation is now complete.



Generator Joe

4016 Quartz Drive
Santa Rosa, CA 95405
Phone: 707 539-9003
Fax: 707 539-5212

Email: sales@generatorjoe.NET
Web www.generatorjoe.NET

Operating Instructions

Using your Reliance Transfer Switch and Your Portable Generator



**Warning: Do not operate a generator in an enclosed area.
Do not operate a generator where the exhaust
fumes can accumulate in an enclosed area.**

You want your generator to be ready when you need it. Therefore, it is important to perform the following steps at least once a month to keep the generator in peak running condition.

- Start and run your generator under load regularly.
- Keep the fuel tank filled with fresh fuel.

It is not necessary to turn off any circuits in the load center when supplying generator power with the transfer switch, even when the utility power is operating normally. The double-throw action of these switches prevents feeding generator power to the utility and, conversely, prevents feeding utility power to the generator.

Transferring from Utility Power to Generator Power

1. Plug the female connector of the generator power cord into the power inlet box or the power inlet on the transfer switch. All circuit selector switches on the transfer switch should be in the LINE or OFF position.
2. Insert the male plug of the power cord into the outlet on the generator.
3. Start the generator **outdoors**. Follow the procedures described in the generator owner's manual furnished by the manufacturer of the generator.
4. Select the circuits to be powered by the generator by moving the corresponding switches on the transfer switch to the GEN position. Use only necessary household items when under generator power.
5. Alternate use of larger loads (furnace motors, well pumps, refrigerators, etc.) to balance the load. See "Balancing the load" on page 4. Do not exceed the maximum wattage of the transfer switch.
6. A 15 amp. transfer switch circuit breaker will limit that circuit to a maximum of 15 amps when in the GEN position. If you have moved a circuit selector switch on such a 15-amp circuit to the GEN position that controls a branch circuit that normally draws more than 15 amps, it may be necessary to turn off some of the appliances on that circuit to avoid exceeding the 15-amp load for that circuit.
7. Determine circuit wattage by using the wattmeters on the transfer switch, or from the nameplate on each appliance or motor. Very small loads may not be sufficient to cause a meter to register.
8. Models with suffix -B and -D do not have watt meters. Determine wattage from the nameplate on each appliance or motor.
9. Make a note of any excessive loads. These loads must be turned off during generator operation.

Transferring from Generator Power to Utility Power

1. Return all circuit selector switches to the LINE position.
2. Follow the procedures in the generator owner's manual to turn off the generator.
3. Unplug the power cord.

Notes on Models Without Watt Meters

If there are no watt meters for checking appliance or motor load, check the nameplate on each appliance or motor and note the load for each.

The total running wattage for each of these models is as follows:

Model Q206	5000 watts
Models Q306, Q310	7500 watts
Models Q506, Q510	12500 watts

During an emergency situation with the generator running, the circuit selector switches should be in the OFF or LINE position when a particular load is not needed. Failure to limit the total load to the total running wattage may cause the generator to stall or create an undervoltage condition that could damage an appliance motor.

Specifications and Parts List

Model #	Q206	Q306	Q506	Q310	Q510
Max. Watts	5000	7500	12500	7500	12500
Max. single-pole circuits	6	6	6	10	10
Max. double-pole and multi-wire circuits	3	3	3	5	5
# of handle ties provided	1	1	1	2	2
Max. combined loads @ 125 VAC	40A	60A	100A	60A	100A
Max. combined loads @250VAC	20A	30A	50A	30A	50A
Max. load/circuit from generator	2-30A 4-20A	2-30A 4-20A	2-30A 4-20A	2-30A 8-20A	2-30A 8-20A
Max. load/circuit from load center	2-30A 4-20A	2-30A 4-20A	2-30A 4-20A	2-30A 8-20A	2-30A 8-20A
Power inlet, NEMA* configuration	L14-20	L14-30	CS6375 non-NEMA	L14-30	CS6375 non-NEMA
Minimum cord gauge	AWG 12	AWG 10	AWG 6	AWG 10	AWG 6
No. of conductors (wires)	4	4	4	4	4
Conduit length	18"	18"	18"	18"	18"
Conduit, trade-size diameter	¾"	¾"	¾"	1"	1"
Optional Power Inlet Catalog #	PB20	PB30	PB50	PB30	PB50
Shipping weight (lbs)	15	15	15	23	23
Dimensions (H x W x D)	13 x 7 ¾ x 4 ½			13 x 11 ¾ x 4 ½	

*National Electrical Manufacturer's Association

Transfer Switch Parts List

Description	Part#	Description	Part#
Circuit breaker, 15 A S.P.	8491	Power inlet, 20 A	L1420F
Circuit breaker, 20 A S.P.	8492	Power inlet, 30 A	L1430F
Circuit breaker, 20 A D.P.	8493	Power Inlet, 50 A	LL550F
Circuit breaker, 30 A D.P.	8494	Handle tie	6295
Wattmeter, 20 / 30 A	7230	Power Inlet Filler Panel	6271
Wattmeter, 50 / 60 A	7231	Electronic Meter	7201
Current Transformer (C.T.)	7222	Electronic Meter C.T.	7223
Switch, 30A SPDT	7801		

Optional Accessories

Power Inlet Boxes

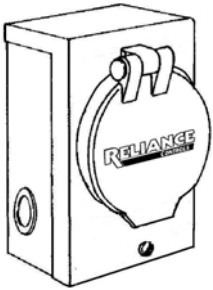

Ideal for installations where the house electrical panel is located indoors. No need to run the power cord from the generator to the transfer switch through a door or window. This weather-tight power inlet box can be mounted on the exterior of the house. Run wiring through the wall from the inlet box to the transfer switch installation inside. The generator power cord may then be plugged into the power inlet box.

Catalog#	Connector configuration	Inlet description	For use with models
PB20	L14-20	4-wire weather-tight male	Q206
PB30	L14-30	4-wire weather-tight male	Q306 and Q310
PB50	CS6364	4-wire weather-tight male	Q506 and Q510

Power Cords



These heavy duty cord sets are the connecting link between the generator and the Reliance transfer switch or the power inlet box. The 4-wire locking plug and connector match up with the power inlet on each Reliance transfer switch and with the inlet on the power inlet box. Most portable generators suitable for 120/240 full-power operation are supplied with either a 20-amp or 30-amp, 4-wire locking receptacle that accepts the locking plug and connector on each end of the cord set.



GeneratorJoe

4016 Quartz Drive
 Santa Rosa, CA 95405
 Phone: 707 539-9003
 Fax: 707 539-5212
 Email: sales@generatorjoe.NET
 Web www.generatorjoe.NET

Reliance Controls Corporation is pleased that you have made the decision to purchase this product. We have been manufacturing innovative, quality electrical controls for nearly 100 years. Our products are backed by one of the best warranties in the industry.

Reliance transfer switches are



Warranty

Each Reliance transfer switch or accessory is guaranteed against mechanical or electrical failure due to manufacturing defects for a period of 24 months following shipment from the factory. The manufacturer's responsibility during this warranty period is limited to repair or replacement, free of charge, of products proving defective under normal use or service when returned to the factory, transportation charges prepaid. Guarantee is void on products that have been subjected to improper installation, misuse, alteration, abuse or unauthorized repair. The manufacturer makes no warranty with respect to the fitness of any goods for a user's particular application and assumes no responsibility for proper selection and installation of its products. This warranty is in lieu of all other warranties, expressed or implied, and limits the manufacturer's liability for damages to the cost of the product. This warranty gives you specific legal rights, and you may have other rights, which vary from state to state.



GeneratorJoe

4016 Quartz Drive
Santa Rosa, CA 95405
Phone: 707 539-9003
Fax: 707 539-5212
Email: sales@generatorjoe.NET
Web www.generatorjoe.NET